

Plumbers and Factory Supplies



www.plumbersandfactory.com

Plumbing Maintenance and Repair Catalog

Wholesale Distributors to Plumbing, Maintenance & Repair Markets
2645 Morse Road Columbus, OH 43231-5931 (614) 478-2645 (800) 589 2645 Fax(614) 478-4111
www.plumbersandfactory.com



Plumbers & Factory Supplies, Inc.

Table of Contents

Volume II

Fixtures.....2-9

Faucets.....10-16

Valves.....17-18

Tubular Brass.....19-21

Tubular Plastic.....22-23

Brass Strainers.....24

Stops/Supplies.....25

Fittings.....26-27

Miscellaneous Plumbing.....28-30

Toilet Seats.....31

Water Heaters.....32

Water Heater Accessories.....33-34

Garbage Disposals.....35

Sump Pumps.....36

Bath Cabinets.....37

Solvents/Cements.....38-39

Chemicals/Compounds.....39-42

Tools and Accessories.....43-50

Pipe and Fittings.....51

Phone and Fax Order Page.....52

Credit Application.....53-55



Plumbers & Factory Supplies, Inc.

Water Closets



Mansfield

The Alto 130-160 Round ultra low flush (ULF) vitreous china toilet, uses less than 1.6 gal/flush
12" Rough In

Mfg#
130-160
round



Mansfield

The Alto 135-160 elongated ultra low flush (ULF) vitreous china toilet, uses less than 1.6 gal/flush
12" Rough In

Mfg#
135-160
elongated



Mansfield

The Maverick 103-102 round high volume 3" flush valve
Only 1.6 gal/flush

Mfg#
103-102
round



Mansfield

The Maverick 101-102 elongated high volume 3" flush valve
Only 1.6 gal/flush

Mfg#
101-102
elongated



Mansfield

The Alto SmartHeight elongated 3" taller than standard bowls
1.6 gal/flush
12" Rough In

Mfg#
137-160

Plumbers & Factory Supplies, Inc.

Water Closets



THE BOLD LOOK
OF **KOHLER**

The Wellworth 3423 round
1.6gal/flush

Mfg#
3423-0
Round



THE BOLD LOOK
OF **KOHLER**

The Wellworth 3422 elongated
1.6gal/flush

Mfg#
3422-0
elongated



The Cimarron 3497 round
Class 5 flushing system
1.6 or 1.4 gal/flush

Mfg#
3497-0
Round



The Cimarron 3496 elongated
Class 5 flushing system
1.6 or 1.4 gal/flush

Mfg#
3496-0
elongated

Plumbers & Factory Supplies, Inc.

Lavatories

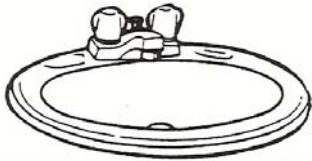

Drop-In Bathroom Lavatory
 Oval 19" x 16"
 Self-rimming, installs fast and easy.
 Vitreous China Lavatory

Mfg#
 251
 White



Drop-In Bathroom Lavatory
 Round 19"
 Self-rimming, installs fast and easy.
 Vitreous China Lavatory

Mfg#
 249
 White



Wall-Mounted Lavatories
 19" x 17" Wall Mounted
 Vitreous China Lavatory

Mfg#
 1917

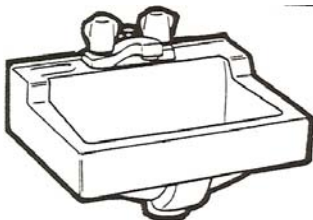

Wall-Mounted Lavatories
 Space-saver lavatory only 16" x 13"
 Vitreous China Lavatory

Mfg#
 1613
 White

Plumbers & Factory Supplies, Inc.

Enameled Steel Fixtures

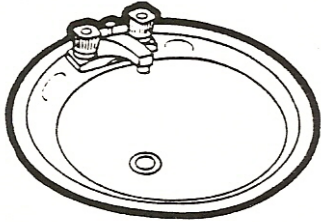

Enameled Round Steel Lavatory
19" round

Mfg#
021-2435
White

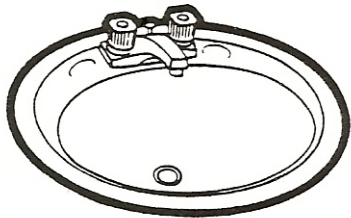

Oval Steel Lavatory
20" x 17" oval

Mfg#
021-2445
White



Porcelain-On-Steel 5' x 30" tub Straight tiling edge. Seamless and rustproof construction, Available in left or right models.

Mfg#
011-2365
LH White

011-2364
RH White



Compact
Porcelain-On-Steel
4½' x 30" tub
Straight tiling edge
Seamless and rustproof construction
Available in left or right models

Mfg#
011-2303
LH White

011-2302
RH White

Plumbers & Factory Supplies, Inc.

Tubwall Kits

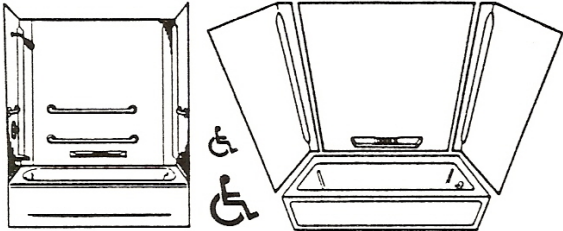

3-Piece Deluxe Fiberglass Durawall Bathtub Walls

Mfg#
350 WHT

Can be trimmed down to accept window kit

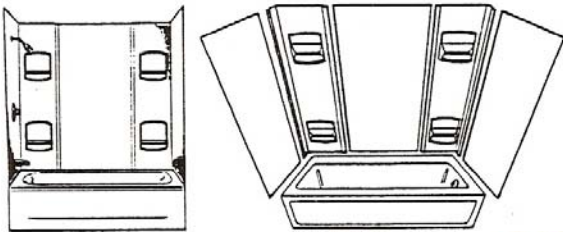

Stylemate Thermo plastic Bathtub Walls
5 panel w/ 4 shampoo/soap shelves

Mfg#
950

Can be installed over drywall or like surfaces

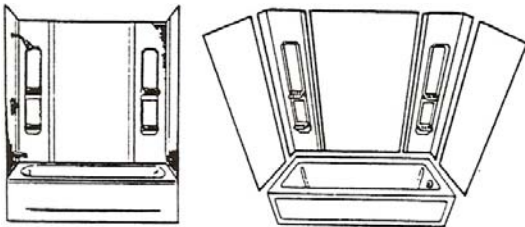

Durawall Bathtub Walls
Deluxe 5-Piece Durawall Co/Poly Bathtub Walls

Mfg#
51
White

Can be installed over existing ceramic or plastic tile

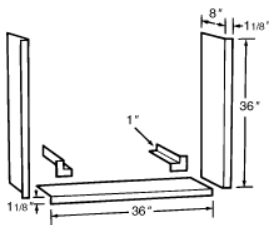

White fiberglass window trim kit

Mfg #
300.600W





Plumbers & Factory Supplies, Inc.

Tub and Shower Kits

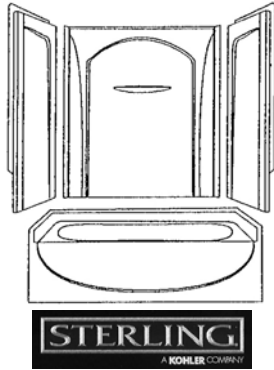

Acclaim 60" Bath/Shower System

60" x 31½" x 73½"
(rough-in dimensions)
4 piece high gloss finish

Order By Component

Mfg#
71094100-0
complete wall kit

71091120-0
RH Tub

71091110-0
LH Tub



Ensemble Shower

Receptor and Wall Surround
36" x 35¼" x 77"
48" x 35¼" x 77"
60" x 35¼" x 77"
(rough-in dimensions)

Order By Component

Mfg#
72205100-0 (end wall)

72101100-0 (36" base)
72202100-0 (36" back wall)

72121100-0 (48" base)
72222100-0 (48" back wall)

72131100-0 (60" base)
72232100-0 (60" back wall)

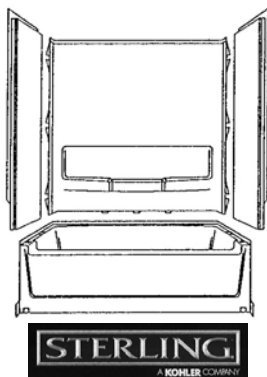

Advantage 60" Bath/Shower System

60" x 31¼" x 73¼"
(rough-in dimensions)
Swirl Gloss Finish

Order By Component

Mfg#
61031110-0 LH Tub
61031120-0 RH Tub
61034100-0 Wall Kit



Plumbers & Factory Supplies, Inc.

Tub/Shower Kits



Performa Bath Tub
60" x 30" tub
Durable High Gloss Finish

For use with ceramic tile and wall kit

Mfg#
71041110-0 LH Tub
71041120-0 RH Tub
71044100-0 wall kit

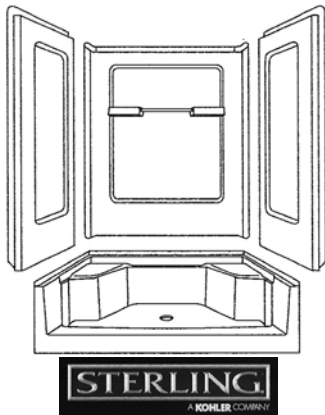

Advantage 48" Shower
Seated Shower Receptor and Surround
48" x 35-1/4" x 73-1/4"
(rough-in dimensions)
Swirl Gloss Finish

Order By Component

Mfg#
62031100-0 base
62034100-0 wall

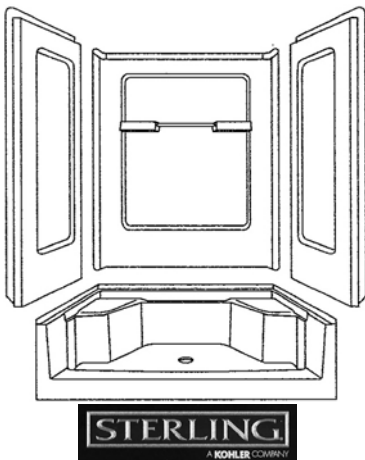

Advantage 60" Shower
Seated Shower Receptor and Surround
60" x 35-1/4" x 77-1/4"
(rough-in dimensions)
Swirl Gloss Finish

Order By Component

Mfg#
62041100-0 base
62044100-0 wall



Plumbers & Factory Supplies, Inc.

Shower Bases

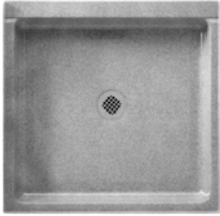

Swan 36" x 36" Shower Base

Mfg#
RI-3636

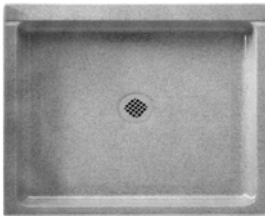

Swan 32" x 48" Shower Base

Mfg#
RI-3248

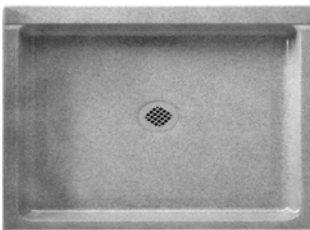

Swan 32" x 60" Shower Base

Mfg#
RI-3260

Plumbers & Factory Supplies, Inc.

Stainless Steel Sinks

Dayton Sinks



Dayton Double Bowl
 Bowl Depth: 6-1/2"
 3hole / 4hole

Mfg#
 D-23322-3
 3-hole
 D-23322-4
 4-hole

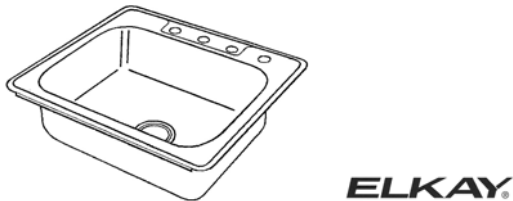

Dayton Single Bowl
 Bowl Depth: 6-1/2"
 3hole / 4hole

Mfg#
 D-12522-3
 3-hole
 D-12522-4
 4-hole

Kingsford By Dayton

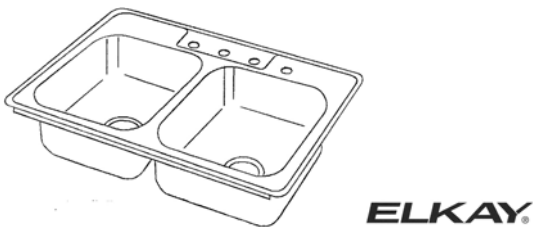

Kingsford Double Bowl
 Bowl Depth: 6"
 3hole / 4hole

Mfg#
 K-23322-3
 3-hole
 K-23322-4
 4-hole

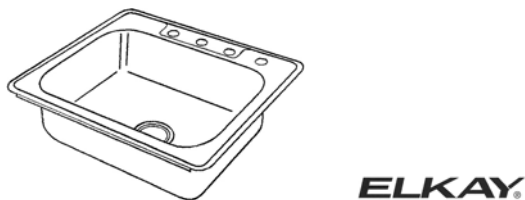

Kingsford Single Bowl
 Bowl Depth 6"
 3hole / 4hole

Mfg#
 K-12522-3
 3-hole
 K-12522-4
 4-hole

Plumbers & Factory Supplies, Inc.

Faucets

Moen Chateau Faucets

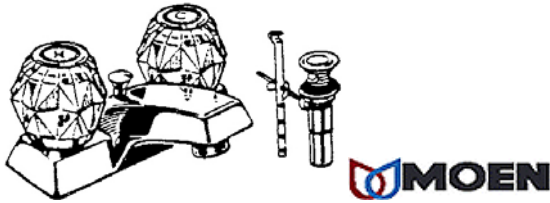

Two-Handle lavatory faucet with waste assembly and clear acrylic handles. Chrome.

Mfg# 64920

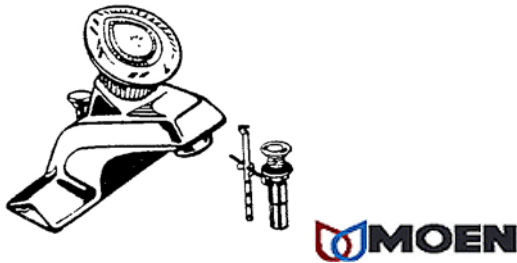

Single handle lavatory faucet with waste assembly

Mfg# 64625



Single handle kitchen faucet. Chrome with aerator.

Mfg# 67425

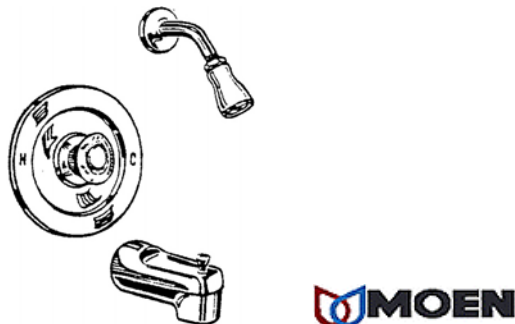

Chrome, with head, arm, flange & spout. Single handle tub/shower set

Mfg# 62320 valve
T183 trim

Order By Component



Plumbers & Factory Supplies, Inc.

Faucets

Kohler Trend

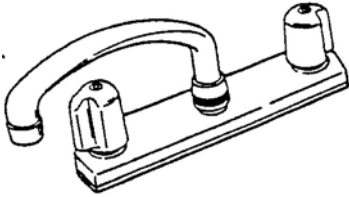

THE BOLD LOOK
OF **KOHLER**.

Trend Kitchen Sink Faucet with metal handles, swing spout, aerator, renewable seats and hand-tighten shank nuts. Maximum countertop thickness 1" (25mm)

Mfg#
K-11920-U
K-11925-U
(w/spray)

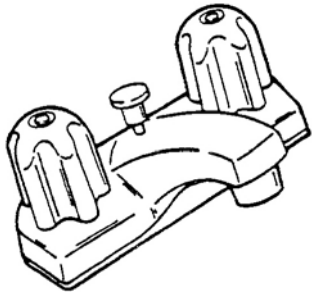

THE BOLD LOOK
OF **KOHLER**.

Trend Lavatory Faucet with metal handles, aerator, renewable seats, hand tighten shank nuts and pop-up drain with 1/4" (32mm) tailpiece, 4" (102mm) centers

Mfg#
K-11800-U

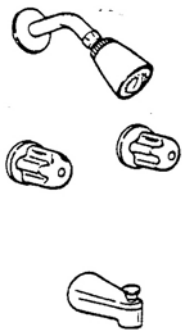

THE BOLD LOOK
OF **KOHLER**.

Trend Bath and Shower Faucet with metal handles 1/2" (13mm) valves with renewable seats, adjustable escutcheons, 1/2" (13mm) I.P.S. diverter spout and ball joint showerhead

Mfg#
K-11608-U

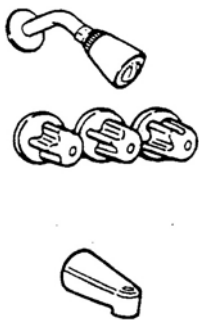

THE BOLD LOOK
OF **KOHLER**.

Trend Diverter Bath and Shower Faucet with metal handles 1/2" (13mm) valves with renewable seats, adjustable escutcheons, 1/2" (13mm) I.P.S.

Mfg#
K-11618-U



Plumbers & Factory Supplies, Inc.

Faucets

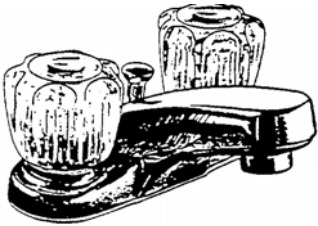

Chrome lavatory faucet
with clear knob handles with pop-up

Mfg#
2522TPP

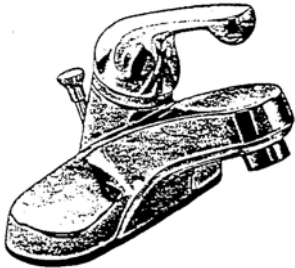

Chrome lavatory faucet
with lever handle with pop-up

Mfg#
520WFTP



Chrome lavatory faucet
with clear knob handle with pop-up

Mfg#
522WFTP



Plumbers & Factory Supplies, Inc.

Faucets

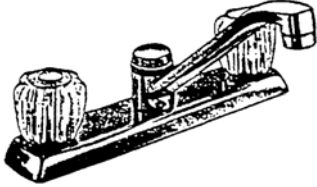

Chrome Kitchen Faucet
with clear knob handles and no spray

Mfg#
2102TP

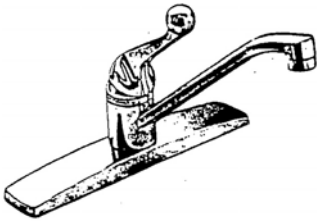

Chrome Kitchen Faucet
with lever handle and no spray

Mfg#
100WFTP

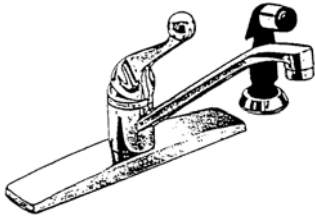

Chrome Kitchen Faucet
with lever handle and black spray

Mfg#
400WFTP



Chrome bath valve with clear knob handle HAF.

Mfg#
1348

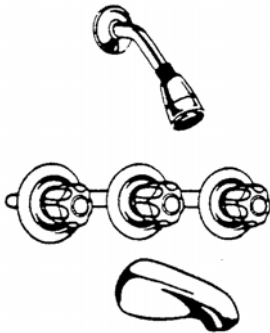

Chrome bath valve with clear knob handles and
showerhead

Mfg#
2683-C



Plumbers & Factory Supplies, Inc.

Faucets



GERBER

Cast Brass Center-Set, 4" centers

Mfg#
7-43-431

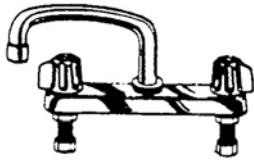

GERBER

Kitchen Faucets, Cast Brass Underbody, Chrome Plated Shell, Tubular Spout

Mfg#
7-42-426

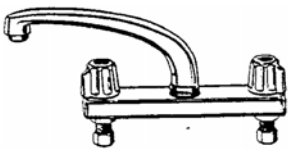

GERBER

Kitchen Faucet, Cast Brass Underbody, Brass Chrome Plated Shell, Cast Brass Spout

Mfg#
7-42-416

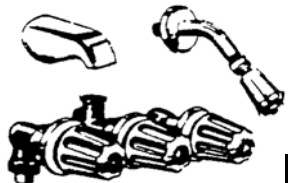

GERBER

Three-Valve Tub & Shower Fitting, Standard Spout, Showerhead & Arm, 8" centers With sliding escutcheon

Mfg#
7-48-031-83



Plumbers & Factory Supplies, Inc.

Faucets

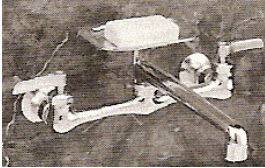

allen

Wall mount kitchen faucet with soap dish
12" Spout

Mfg#
WF300



allen

Single handle with metal handle less pop-up

Mfg#
LS501M



allen

Single handle with brass pop-up

Mfg#
LS501

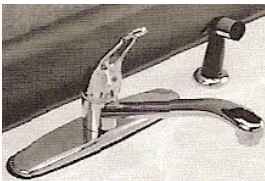

allen

Single handle with loop handle less spray

Mfg#
SK200R

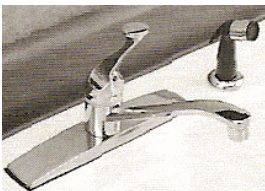

allen

Single handle with spray

Mfg#
SK201

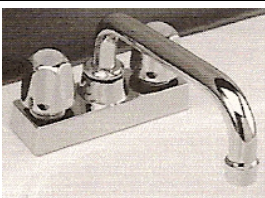

allen

Laundry tray with Aerator & hose end adaptor

Mfg#
B100LT



Plumbers & Factory Supplies, Inc.

Flush Valves

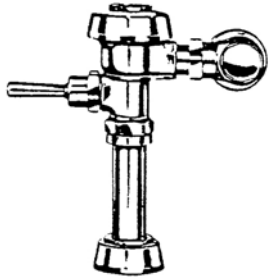

SLOAN
Valve Company

Regal Flushometer
Model 110-YB
(standard, 4.5 gal. flush cycle)
Model 111-YB
(low consumption, 1.6 gal. flush cycle max.)

Mfg#
110-YB

111-YB

Exposed type Flushometer for floor mounted or wall hung bowls with 1-1/2" exposed top spud.

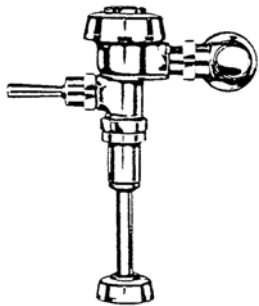

SLOAN
Valve Company

Regal Flushometer
Model 186-YB
(standard, 1.5 gal. flush cycle)
Model 186-1-YB
(low consumption, 1 gal. flush cycle max.)

Mfg#
186-YB

186-1-YB

Exposed type Flushometer for Washout Urinal with 3/4" exposed top spud.

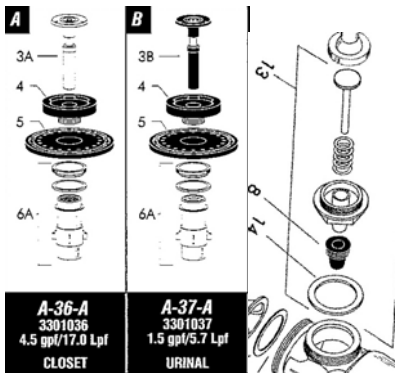

Diaphragm Repair Kit
Closet Kit

Mfg#
A-36-A

Urinal Kit
(Specify closet or urinal)

Mfg#
A-37-A

Handle Repair Kit

Mfg#
B-50-A

SLOAN
Valve Company



Auto Flush Valve
for Zurn and Sloan
toilets and urinals

Mfg#
G01-805

Plumbers & Factory Supplies, Inc.

Miscellaneous Valves



MODEL
S-1002



Stop Ball Valve, Copper to Copper
 $\frac{1}{2}$ " , $\frac{3}{4}$ " , 1" , 1 $\frac{1}{4}$ " , 1 $\frac{1}{2}$ " , 2"

Mfg#
S-1002
specify size



T-521



Boiler Drain

$\frac{1}{2}$ " Male
 $\frac{3}{4}$ " Male

Mfg#
T-521



Stop and Waste Valve
 Compression to Compression
 $\frac{1}{2}$ " Compression
 $\frac{3}{4}$ " Compression

Mfg#
T-512



MODEL
T-802



Compression Ball Valve
 $\frac{1}{2}$ " , $\frac{3}{4}$ " , 1"

Mfg#
T-802
specify size



Freeze-less Wall Hydrant
 Anti-Siphon and Frost Proof
 $\frac{1}{2}$ " x $\frac{1}{2}$ " x 8"
 $\frac{1}{2}$ " x $\frac{1}{2}$ " x 10"
 $\frac{1}{2}$ " x $\frac{1}{2}$ " x 12"

Mfg#
17CP-8
17CP-10
17CP-12

Will Not Freeze Even With Hose Left Connected



Plumbers & Factory Supplies, Inc.

Tubular Brass

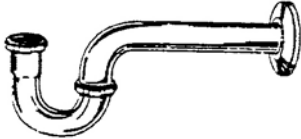

P-Traps
1¼" P-20g
1½" P-20g

Mfg#
P38-002
P38-005

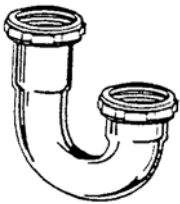

J-Bends for Tube Traps w/Nuts & Washers
1¼" L/CO Budget
1½" L/CO Budget

Mfg#
P38-015
P38-110

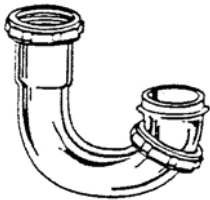

Sink J-Bends w/ Captive Nuts & Washers
1¼" Sink J-Bend
1½" Sink J-Bend

Mfg#
650-1
654-1

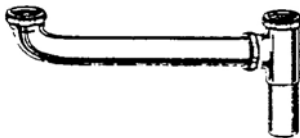

EO Sink Wastes S/J
1½" x 16" C to C-Budget
1½" x 16" C to C-20g

Mfg#
2108A
108A



Plumbers & Factory Supplies, Inc.

Tubular Brass



Trap Offsets
 1¼" Double Slip-20g
 1½" Double Slip 20G

Mfg#
 1046-1
 1046A-1

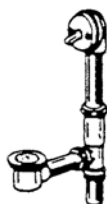

Gerber 20 Gauge Brass Waste & Overflow
 w/brass-plated slip nuts

Mfg#
 41-818



Slip Extension Tubes

1¼" x 6" Budget
 1¼" x 8" Budget
 1¼" x 12" Budget
 1½" x 6" Budget
 1½" x 8" Budget
 1½" x 12" Budget

Mfg#
 790-1
 790A-1
 P38-067
 792-1
 792A-1
 P38-071

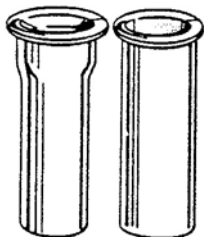

Sink Tail Pieces

1½" x 6" Budget
 1½" x 8" Budget
 1½" x 12" Budget
 1½" x 12" Double Flg - Budget

Mfg#
 800-20-1
 P38-059
 P38-060
 803BD-1



Plumbers & Factory Supplies, Inc.

Tubular Brass

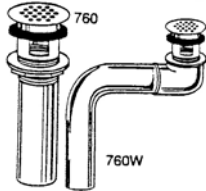

Cast Grid P.O. Plugs
P.O. Plug w/1¼" x 6" -17g Tailpiece
Wheelchair P.O. Plug w/1¼" -17g Tailpiece

Mfg#
760-1
760W-1

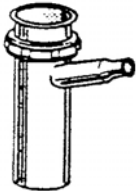

Branch Tailpieces
1½" x 8" - ½" Nom Swt

Mfg#
200-082

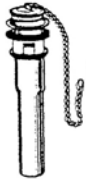

Wrot Plugs w/Chain & Stopper
1¼" X 8" P.O. Ind Boxed 2 pc -Budget

Mfg#
764A-1

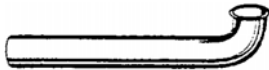

Hi-Line Waste Arms
15" for 16" EO-Budget

Mfg#
2138C-1



Slip Joint Waste Arms
15" slip joint waste arm Cat.21

Mfg#
137C-1



Bath Waste Conversion Kits
Trip Lever Conversion Kit, Polished Brass
(1¼" or 1½")
Uni-Lift Conversion Kit, Chrome Plate (1¼")
w/1½" Adapter Ring
Uni-Lift Conversion Kit, Polished Brass (1¼")
w/1½" Adapter Ring

Mfg#
K26PB
K27
K27PB



Plumbers & Factory Supplies, Inc.

Tubular Plastic

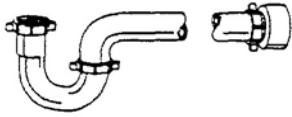

P-Traps

1/4" P-Trap, less flange, bagged
1/2" P-Trap, bagged
1/2" P-Trap ABS

Mfg#
P-9701BG
P-9704BG
A-9704B

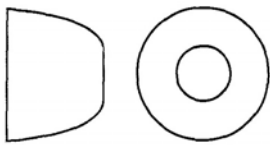

Deep Tubular Escutcheon

Fits 1/2" tubular, extra deep 3", extra wide 4" base

Mfg#
922-6W

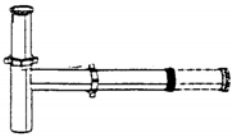

Disposer Kit

1/2" Telescopic Disposer Kit for In-Sink-Erator or GE

Mfg#
P-9100T

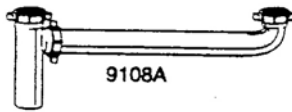

End Outlet Wastes w/Baffle

1/2" x 16" Slip Joint

Mfg#
P37-007 PVC
P39-007 ABS

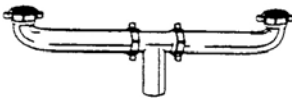

Center Outlet Wastes w/Baffle

1/2" x 16" Slip Joint

Mfg#
P-9114A PVC
A-9114A ABS



Waste Arms

1/2" x 15" Slip Joint

Mfg#
P-9137C PVC
A-9137C ABS

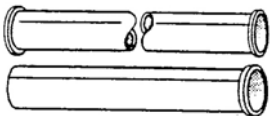

Sink Tail Pieces

1/2" x 8"

1/2" x 16" Double Flanged

Mfg#
P-9801 PVC

P37-019 PVC
P39-019 ABS

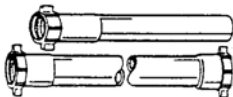

Extension Tubes

Slip Connect 1/2" x 8"
Slip Connect 1/2" x 12"
Double Connect 1/2" x 16"

Mfg#
P-9792A PVC A-9792A ABS
P-9793A PVC A-9793A ABS
P37-018 PVC P39-018 ABS



Plumbers & Factory Supplies, Inc.

Tubular Plastic

(Specify White PVC or Black ABS)

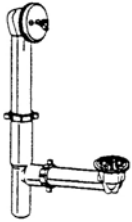

Bath Wastes w/ABS or PVC Tee
Trip Lever

Mfg#
P-9226 PVC
A-9226 ABS

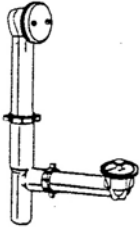

Lift and Turn

Mfg#
P-8227 PVC
A-8227 ABS

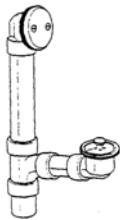

Schedule 40 Bath Wastes
w/ 1 1/2" Waste Shoe
Lift and Turn Drain with Overflow Plate Only
Schedule 40

Mfg#
P-7225B PVC
A-7225B ABS

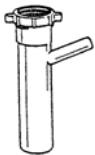

Branch Tailpieces
1 1/2" x 8" Slip Joint, 3/4" Branch

Mfg#
PP-9817

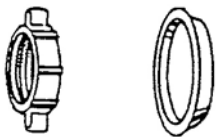

Slip Joint Nut Poly Washers

1 1/2" Slip Joint Nut
1 1/4" Slip Joint Nut
1 1/2" x 1 1/2" Polyethylene Washer
1 1/2" x 1 1/4" Polyethylene Washer

Mfg#
P-9001
P-9001A
P-9002
P-9003



Plumbers & Factory Supplies, Inc.

Brass Strainers



'Lucky 7', chrome plated brass body w/stainless steel basket, metal slide post, heavy locknut, extra thick washer, machine cut threads

Mfg#
L7SS



Chrome Finish Economy Stainless Steel Body Basket Strainer Assembly

Mfg#
11SS

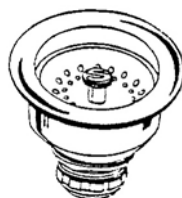

'Supreme' stainless steel body and basket, locking cup, neoprene stopper w/snap-in basket, length 2 $\frac{3}{4}$ " (will fit deep cast iron sinks)

Mfg#
14SS



'Spin-N-Lock' stainless steel body w/ stainless steel screw-in basket

Mfg#
17SS



Plumbers & Factory Supplies, Inc.

Stops/Supplies

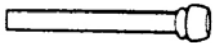

Lav/Sink
Poly or Chrome
3/8" x 12"
3/8" x 20"
3/8" x 30"
3/8" x 36"

Poly Mfg#	Chrome Mfg#
P1-12A	1-12AC
P1-20A	1-20AC
P1-30A	1-30AC
P1-36A	1-36AC

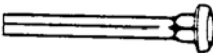

Closet
Poly or Chrome
3/8" x 12"
3/8" x 20"

Poly Mfg#	Chrome Mfg#
P1-12DL	1-12DE
P1-20DL	1-20DE

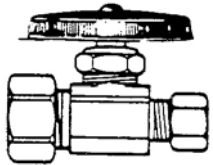

Straight Stop
3/8" Comp x 5/8" Comp

Mfg#
CR-14

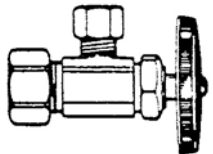

Angle Stop
3/8" Comp x 5/8" Comp

Mfg#
CR-19

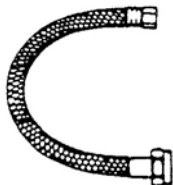

Braided Flex Connectors
Lav 3/8" Compression x 1/2" F.I.P x 12"
Lav 3/8" Compression x 1/2" F.I.P x 20"
Closet 3/8" Compression x 1/2" F.I.P x 12"
Closet 3/8" Compression x 1/2" F.I.P x 20"
Dishwasher 3/8" Compression x 12 F.I.P x 48"
High Pressure Non-Braided Washing Machine 3/4" x 3/4" FH x 72"
Stainless Steel Washing Machine 3/4" x 3/4" FH x 72"

Mfg#
B1-12A
B1-20A
B1-12DL
B1-20DL
B8-48DW6D
J04-006
298002



Plumbers & Factory Supplies, Inc.

Compression Fittings Rough Brass



Unions

$\frac{5}{8}$ " x $\frac{3}{8}$ " Compression Union
 $\frac{5}{8}$ " x $\frac{5}{8}$ " Compression Union
 $\frac{3}{8}$ " x $\frac{3}{8}$ " Compression Union

Mfg#
 62-10-6
 62-10
 62-6

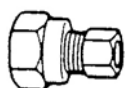

Female Unions

$\frac{1}{2}$ " FIP x $\frac{3}{8}$ " Compression Adapt
 $\frac{3}{8}$ " FIP x $\frac{3}{8}$ " Compression Adapt

Mfg#
 66-6-8
 66-6-6



Male Unions

$\frac{3}{8}$ " MIP x $\frac{3}{8}$ " Compression Adapt
 $\frac{1}{2}$ " MIP x $\frac{3}{8}$ " Compression Adapt
 $\frac{1}{2}$ " MIP x $\frac{5}{8}$ " Compression Adapt
 $\frac{3}{4}$ " MIP x $\frac{5}{8}$ " Compression Adapt

Mfg#
 68-6-6
 68-6-8
 68-10-8
 68-10-12

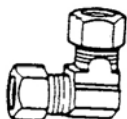

Elbows

$\frac{3}{8}$ " x $\frac{3}{8}$ " Compression 90°
 $\frac{5}{8}$ " x $\frac{3}{8}$ " Compression 90°

Mfg#
 65-6
 65-10-6

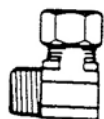

Male Elbows

$\frac{3}{8}$ " MIP x $\frac{3}{8}$ " O.D. Compression 90°
 $\frac{1}{2}$ " MIP x $\frac{3}{8}$ " O.D. Compression 90°
 $\frac{1}{2}$ " MIP x $\frac{1}{2}$ " O.D. Compression 90°

Mfg#
 69-6-6
 69-6-8
 69-8-8



Comp Sleeves

$\frac{3}{8}$ " Brass Compression Sleeve
 $\frac{5}{8}$ " Brass Compression Sleeve
 $\frac{3}{8}$ " Poly Compression Sleeve

Mfg#
 60-6
 60-10
 60PT-6



Comp Nuts

$\frac{3}{8}$ " Compression Nut
 $\frac{5}{8}$ " Compression Nut

Mfg#
 61-6
 61-10



Plumbers & Factory Supplies, Inc.

SharkBite™ Push-Fit Fittings

Instant Push Fit Connection For Increased Ease of Use
 No Soldering Needed
 Certified to 200 PSI and 180° F
 Fits OD Copper, CPVC, and PEX and Polybutalene Pipe
 Contains An Integral Tube Support Liner That Is Effective In Supporting PEX Tubing
 Compact and Robust Bronze Body
 Certified to NSF-61 Product Standard for Use in Potable Water Systems

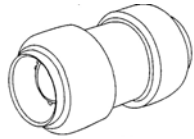

Straight Coupling

$\frac{1}{2}$ " x $\frac{1}{2}$ "
 $\frac{3}{4}$ " x $\frac{3}{4}$ "

Mfg#
 U008
 U016

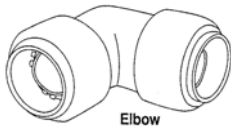

Elbow

$\frac{1}{2}$ " x $\frac{1}{2}$ "
 $\frac{3}{4}$ " x $\frac{3}{4}$ "

Mfg#
 U248
 U256

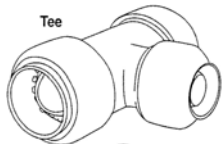

Tee

$\frac{1}{2}$ " x $\frac{1}{2}$ "
 $\frac{3}{4}$ " x $\frac{3}{4}$ "

Mfg#
 U362
 U370

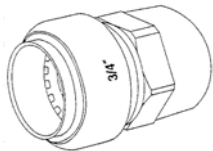

Straight Connector

$\frac{1}{2}$ " x $\frac{1}{2}$ " male and female
 $\frac{3}{4}$ " x $\frac{3}{4}$ " male and female

Mfg#
 F M
 U072 U120
 U088 U134



Disconnecting Clip

$\frac{1}{2}$ "
 $\frac{3}{4}$ "

Mfg#
 U710
 U712



Plumbers & Factory Supplies, Inc.

Miscellaneous Plumbing

	<p>Wax Rings Regular Wax Ring Regular Wax Ring w/horn Jumbo Wax Ring Jumbo Wax Ring w/horn</p>	<p>Mfg# 90-210 90-220 90-241 90-243</p>
	<p>Soldering Flux Brush</p>	<p>Mfg# 50-400</p>
	<p>Teflon Tape $\frac{1}{2}$" x 260" $\frac{3}{4}$" x 520"</p>	<p>Mfg# 15-162 15-176</p>
	<p>Copper Fitting Brush $\frac{1}{2}$" $\frac{3}{4}$"</p>	<p>Mfg# R-5553 R-5555</p>
	<p>Hanger Iron $\frac{3}{4}$" x 10' 20 gauge galvanized</p>	<p>Mfg# 84030</p>
	<p>Johnny Bolts $\frac{1}{4}$" x 2$\frac{1}{4}$"</p>	<p>Mfg# 90-104</p>
	<p>Caulking Gun 32 45</p>	<p>Mfg# 12440 12445</p>
	<p>Tank to bowl bolt</p>	<p>Mfg# C03-250</p>
	<p>Steel wool pads</p>	<p>Mfg# 106103</p>
	<p>Plumbers roll 1$\frac{1}{2}$ x 10 open mesh Grit Cloth</p>	<p>Mfg# R-5503</p>



Plumbers & Factory Supplies, Inc.

Miscellaneous Plumbing

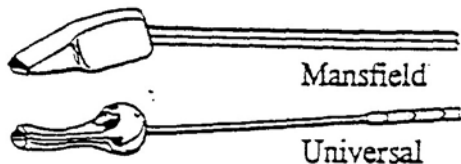

Trip Levers
Mansfield
Universal

Mfg#
43CH
T01-001



Dual Thread Aerator

Mfg#
100MKB2

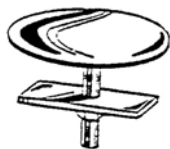

Faucet Hole Cover
1 $\frac{3}{4}$ faucet hole cover w/toggle bolt chrome plated

Mfg#
B10-200



Shower Rod
1" x 5' aluminum

Mfg#
S02-055



S02-150
S02-151

S02-152

Shower Rod Flange
Shower rod flange, plastic expando
Shower rod flange, chrome plated expando
Shower rod flange, chrome plated non-adjustable

Mfg#
S02-150
S02-151
S02-152



Chrome plated shower arm

Mfg#
614506



Chrome plated tub spout
Diverter
Non-diverter

Mfg#
71-3902
616036



Round face plate with lever

Mfg#
618068



Plumbers & Factory Supplies, Inc.

Miscellaneous Plumbing



Fluidmaster.

Fill Valve
Fluidmaster Corrosion Proof Ball Cocks
Seal Repair Kit

Mfg#
400A
242



BrassCraft.

Fill Valve
Brasscraft Corrosion Proof Ball Cocks
Seal Repair Kit

Mfg#
BCT015



Mansfield.

Flush Valves
Mansfield 3.5 GPF Flush Valve
Service pack for 3.5 GPF Flush Valve
Mansfield 1.6 GPF Flush Valve

Mfg#
210-11-1/2
630-0030
211ULF



korky

Flappers
Black replacement tank flapper
Also available in Red (chlorazone)

Mfg#
C04-015
C04-016



BrassCraft.

Flappers
Yellow replacement tank flapper

Mfg#
BCT005P

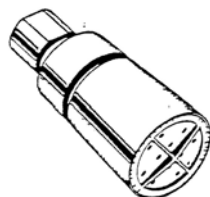

CCC
CENTRAL COMPONENTS CO.

Showerheads
All Metal, zinc die cast, triple chrome plated,
swivel action, plastic face, 3.5 gallon per/minute flow rate

Mfg#
614048



Plumbers & Factory Supplies, Inc.

Toilet Seats

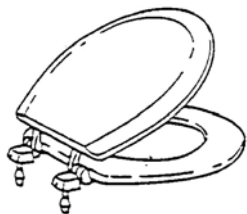

Wood seat for regular round bowl (Budget)
White seat for regular round bowl (Premium)

Mfg#
400TTA
100-000



Wood seat for elongated bowl (Budget)
White seat for elongated bowl (Premium)

Mfg#
84-000
104-000



Plastic seat for regular round bowl

Mfg#
60-000

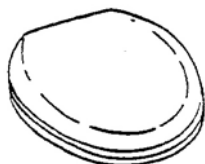

Plastic seat for elongated bowl

Mfg#
64-000



Plastic commercial seat open front no cover
for elongated bowl, white

Mfg#
10SSC



Plumbers & Factory Supplies, Inc.

Residential Water Heaters

NATURAL GAS, 5 YEAR WARRANTY



Vent Size	Overall Height	Diameter	Capacity	Mfg#
3"	57"	17 $\frac{3}{4}$ "	30 gal tall	22V30-30F
3"	46 $\frac{1}{4}$ "	19 $\frac{3}{4}$ "	30 gal short	22V30S-30F
3"	58"	17 $\frac{3}{4}$ "	40 gal tall	22V40-36F1
3"	58 $\frac{3}{8}$ "	18 $\frac{1}{8}$ "	40 gal tall	22V40-F1
3"	49 $\frac{1}{2}$ "	21 $\frac{3}{4}$ "	40 gal short	22V40S-40F
3"	58"	20 $\frac{1}{8}$ "	50 gal tall	22V50-F1
4"	58"	21 $\frac{3}{4}$ "	50 gal tall	42V50-50F



COMMERCIAL NATURAL GAS

Vent Size	Overall Height	Diameter	Capacity	Mfg#
6"	64"	26 $\frac{1}{4}$ "	76 gal	G76-200
6"	66 $\frac{1}{8}$ "	30 $\frac{1}{4}$ "	100 gal	G100-200



ELECTRIC, 5 YEAR WARRANTY

Overall Height	Diameter	Capacity	Mfg#
29 $\frac{1}{2}$ "	22 $\frac{1}{2}$ "	30 gal short	82SV-30-2
45 $\frac{3}{4}$ "	17 $\frac{3}{4}$ "	30 gal	82V30-2
46 $\frac{1}{2}$ "	19 $\frac{3}{4}$ "	40 gal	82V40-2
57"	19"	50 gal	82V52-2
58 $\frac{1}{2}$ "	21"	65 gal	82V66-2
59"	23 $\frac{3}{4}$ "	80 gal	82V80-2

CONTINUOUS TANKLESS WATER HEATERS



Rinnai

External Residential	Internal Residential	Mfg#
15,000 to 199,000 BTHU Capacity .5 to 8.5 gal/min delivered endlessly Natural Gas or Propane Available No Venting Required 9" depth, 14" width, 24" height Easy Installation	15,000 to 180,000 BTHU Capacity .5 to 8.5 gal/min delivered endlessly Natural Gas or Propane Available Direct Vent 9" depth, 14" width, 24" height Easy Installation	2020W (external) 2520-FFU-N (internal)



Plumbers & Factory Supplies, Inc.

Water Heater Accessories



Watts Expansion Tanks

2.1 gallons

4.5 gallons

Mfg#

PLT-5

PLT-12



¾" Temperature and Pressure Relief Valve

Mfg#

TP1100A-4C



Stainless Steel Corrugated Gas Appliance Connectors

½" F.I.P. x ½" F.I.P.

12" 24"

36" 48"

60" 72"

Mfg#

CSSC55

Specify Size

12" through 72"

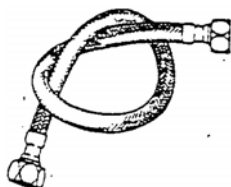

Water Heater Connectors

¾" FIP x ⅞" O.D. Compr. (12" 15" 18" 24")

¾" MIP x ⅝" O.D. Compr. (12" 18" 24")

¾" MIP x ⅞" O.D. Compr. (12" 15" 18" 24")

Mfg#

BWB-08

BWB-25

BWB-28

Specify Size

12" through 24"

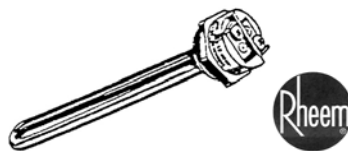

Screw-in Elements

Rheem UV12899

4500 Watt 240V Screw in Element

Mfg#

UV12899



Thermostats

Upper Thermostat with limit

Mfg#

SP-11698

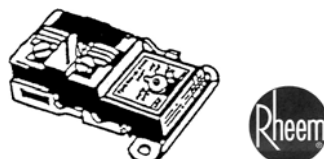

Thermostats

Lower Thermostat only

Mfg#

SP-8295



Plumbers & Factory Supplies, Inc.

Water Heater Accessories



Element Pack
Rheem Universal Element Pack
Tune Up Kit w/ Thermostats

Mfg#
UV20018

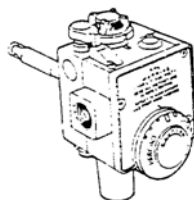

Natural Gas Thermostat
Gas Control Valve 1/2" Connector

Mfg#
SP-8555-B

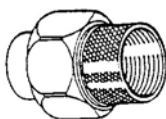

Dielectric Unions
MXC (1/2", 3/4")
FEXC (1/2", 3/4", 1", 2")
MXC (3/4 x 1/2")

Mfg#
3005A
3001A
3007



Dielectric Nipples
3/4 x 3/4 MIP

Mfg#
T575

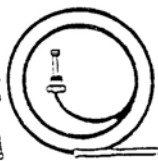

**White
Rodgers**

Thermocouple Replacement Kit
18"
24"
36"
48"

Mfg#
HO6E-18
HO6E-24
HO6E-36
HO6E-48



Aluminum Water Heater Pan
20"
22"
24"
30"

Mfg#
AHP 2022
AHP 2224
AHP 2426
AHP 3032



Plumbers & Factory Supplies, Inc.

Garbage Disposals



Garbage Disposers
 Badger I, 1/3 hp disposal
 Badger I, 1/3 hp disposal with cord

Mfg#
 66916
 66917



Garbage Disposers
 Badger V, 1/2 hp disposal
 Badger V, 1/2 hp disposal with cord
 One year parts warranty in home service

Mfg#
 66914
 66915



Plumbers & Factory Supplies, Inc.

Sump Pumps

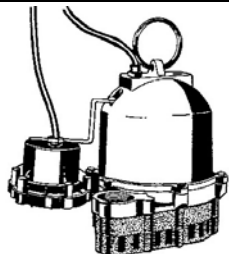

LITTLE GIANT
Pump Company

Little Giant
1/3 hp submersible sump pump

Mfg#
ES-33D1-10

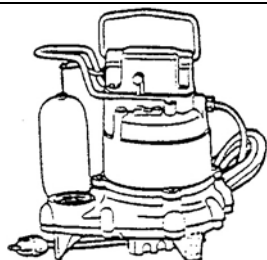

ZOELLER
PUMP CO.

Zoeller
1/3 hp submersible sump pump
sump pump with 15' cord

Mfg#
M53-0001

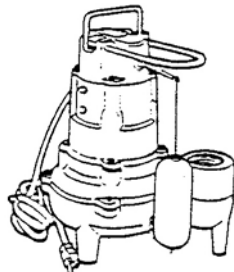

ZOELLER
PUMP CO.

Zoeller
'267 Series' 'Waste Mate'
submersible sewage pump

Mfg#
M267-0001



LEGEND
VALVE

Check Valve
Slip x Slip Union
1 1/2" or 1 1/4"

Mfg#
S-613



ZOELLER
PUMP CO.

Check Valve
Slip x Slip Union
1 1/2" or 1 1/4"

Mfg#
30-0181

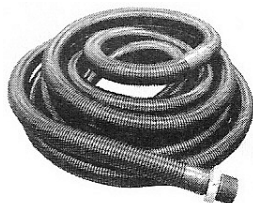

Hose Kits
Flexible Discharge Hose Kits for Sump Pump
24' hose assemblies with 1 clamp and male 1 1/4" IPS adaptor
(Coiled and Tied)

Mfg#
C29-124



Plumbers & Factory Supplies, Inc.

Bath Cabinets

Modular
Bath
Components

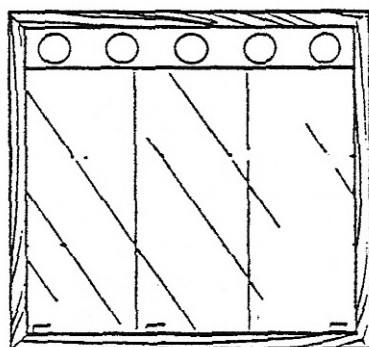

FRAMED MIRRORS WITH
BEVELED GLASS

WALL CABINETS

MIRRORED MEDICINE CABINETS

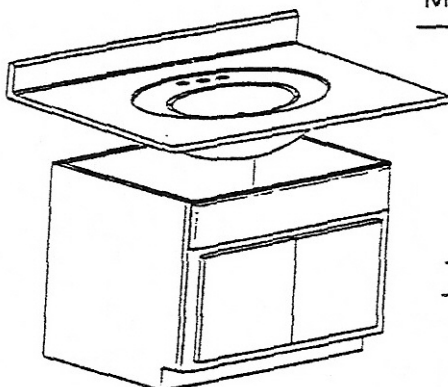

DECORATIVE LIGHTS

VANITY BASES

P&F offers a complete selection of cabinet components to help you custom design your bath.
Call our Sales Staff with your size and specification requirements.

Custom marble tops to match your design specification.

Get exactly what you need and want for the space you have.



Plumbers & Factory Supplies, Inc.

Solvent/Cements



IPS CORPORATION
IPS

ABS Cement

Heavy bodied, fast setting, ABS cement for all classes and schedules through 8" dia

½ pt
1pt
1qt

Mfg#
2773



IPS CORPORATION
IPS

PVC Cement

Heavy bodied, medium setting, clear PVC cement for all classes & schedules, including Schedule 80, through 12" diameter

½ pt
1pt
1qt

Mfg#
717



Oatey

PVC Cement

Heavy bodied clear cement for use on PVC pipes and fittings. Up to 12" diameter for sch. 40 and sch. 80

32oz

Mfg#
31008



IPS CORPORATION
IPS

CPVC Cement

FlowGuard Gold. Medium bodied fast setting CPVC cement for copper tube size pipe and fittings through 2" in diameter

½ pt

Mfg#
11028



IPS CORPORATION
IPS

Hot 'R Cold

Hot 'R Cold – Medium/heavy bodied, very fast setting, clear PVC cement for all classes & schedules through 6" diameter

1qt

Mfg#
727



Oatey

ABS Cement

Medium-bodied black cement for ABS pipe and fittings up to 6" in diameter. For all types and grades of ABS pipe and fittings for DWV

32oz

Mfg#
30902



Plumbers & Factory Supplies, Inc.

Chemicals/Compounds



Cleaner

For PVC, CPVC, ABS, and Styrene piping applications. Fast acting to remove surface dirt and grease.

1 pt
1 qt

Mfg#
C-65



Primer

For surface preparation of all PVC and CPVC pipe and fittings prior to cement application.

1 qt

Mfg#
P-68



PVC/CPVC Adhesive

Two component reactive adhesive for joining, fabricating and repairing PVC and CPVC fittings. Bonds PVC and CPVC to dissimilar materials such as metal, concrete clay and others

White
4oz

Mfg#
810



WD40

Cleans, Lubricates, Penetrates Stuck Metal, Protects against rust and corrosion

8oz

Mfg#
S95-700



Drain Cleaner

THRIFT Drain Cleaner
Nothing Beats Thrift

1 lb

Mfg#
T-100



Plumbers & Factory Supplies, Inc.

Chemicals/Compounds



STA PUT Plumbers Putty
Molds easily, will not harden, crumble, crack, or shrink.

14oz
3 lb
5 lb

Mfg#
25-101
25-103
25-105



Pipe Joint Compound
PRO DOPE lead free

½ pt
1 lb

Mfg#
15-427
15-433



Teflon Pipe Joint Compound
REAL-TUFF lead free

1 pt

Mfg#
15-625



Epoxy Putty
PRO POXY 20, steel reinforced epoxy putty. Two parts, mixes quickly and easily. Cat 16

4oz

Mfg#
25-515



Hand Cleaner

Pre moistened hand cleaning towels specifically formulated for plumbers. Removes industrial paints, lubricants, adhesives, tar, printers ink, sealants, grease, oil, grime, caulks, cement, flux and other stubborn soils.

70
towels

Mfg#
45333



Plumbers & Factory Supplies, Inc.

Chemicals/Compounds



Hand Cleaner
Pumice/lotion hand cleaner

16oz

Mfg#
45-325

Cutting Oil
Dark cutting oil for high speed pipe threading machines

1 gal

Mfg#
40-220

Root Destroyer
R-D Root Destroyer, clears root blocked sewer lines, will not harm trees or shrubs

2 lb

Mfg#
20-602

Flashing Cement
Roof flashing cement, can be applied in the rain

1 gal

Mfg#
25-410

Leak Detector
LEAK DETECTOR for detecting leaks of air, natural gas, refrigerants, CO₂ and other gases

8oz

Mfg#
45-801

Fast Patch Concrete
Perfect for patching sewer outlet, water service, and around drains. Sets up in 5 minutes.







5 lb

Mfg#
963-05



Plumbers & Factory Supplies, Inc.

Chemicals/Compounds

	<p>230 Dynaflex Caulking enhanced latex sealant paintable 10.1 oz</p>	White	Mfg# 18300
	<p>Alex Plus Caulking acrylic plus silicone Paintable 10.1 oz</p>	White	Mfg# 18152
	<p>Kwik Seal Caulking Latex 5.5 oz</p>	White Clear Almond	Mfg# 18001 18008 18013
	<p>100% Silicone Rubber Sealant 10.1 oz</p>	Clear	Mfg# 08641
	<p>100% Silicone Sealant 10.1 oz</p>	White	Mfg# 08640
	<p>KRC-7 ultra foaming bathroom cleaner cleaner/restorer for all fiberglass fixtures</p>	16 oz	Mfg# 95749 2416



Plumbers & Factory Supplies, Inc.

Tools and Accessories



Duct Tape

Mfg#
T20-020



6 in 1 Screwdriver

Mfg#
03208



Expanding Foam

Mfg#
S30-012



Cam Straps

1" x 2' black 1" x 8' green
1" x 4' red 1" x 10' blue
1" x 6' yellow 1" x 12' purple

Mfg#
S20-100 S20-103
S20-101 S20-104
S20-102 S20-105



Latex Gloves

One size fits all
(100 per box)

Mfg#
G50-250



Brown Cotton Jersey Gloves

One size fits all
(12 per box)

Mfg#
J124



Bucket Caddie

5 Gallon high-impact bucket holds a combination of organizational trays (all trays feature 4 sections)

Bucket w/6 small trays
Bucket w/1 large and 4 small trays

Mfg #
T60-101
T60-102



Plumbers & Factory Supplies, Inc.

Tools and Accessories



Water Meter Key

$\frac{5}{8}$ " x 60"

$\frac{5}{8}$ " x 72"

Rebar shaft and handle for greater strength

Mfg#
M25-560
M25-572



Badger Water Meter

Model 25 remote water meter $\frac{5}{8}$ " x $\frac{3}{4}$ " (per cuft) w/ 25' of wire

Mfg#
M25



Propane and Mapp Gas

Temperatures for burning:

Propane: 2300°

Propane 14.1 oz

Mapp: 3300°

Mapp 16 oz

Mfg#
J40-601

J40-600

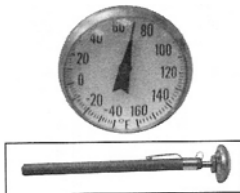

Pocket Test Thermometer

Comes within 2% accuracy

Pocket clip

from 0° to 220° F

Mfg#
J40-701



Hex Head Tapping Screws

zinc plated

Mfg#
F33-103



Cartridge Puller

For the removal of both brass and plastic cartridges

Mfg#
684095



Plumbers & Factory Supplies, Inc.

Tools and Accessories



The Clam
Silver Closet Flange

Mfg#
The Clam



Closet Flange Support
support flange if floor is rotted or if rough-in hole is too large

Mfg#
C01-001



Flange Extension Kit
necessary when repairing, replacing or tiling bathroom floors

Mfg#
CF300



Easy Sheer Inside Pipe Cutter
cuts PVC and ABS
high speed blade with zinc plated shaft
replacement blades

Mfg#
J40-830
J40-831

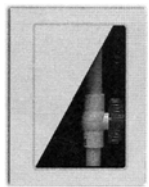

Access Panels
easily installed to eliminate unsightly sheet rock repairs provides future
access to plumbing or wiring
can be painted or wallpapered
8" x 8"
14" x 27"

Mfg#
A05-008
A05-027



Test Plugs
fits cast iron and plastic pipe
molded rubber gasket
galvanized steel flanges
Available in 1 1/2", 2", 3", 4"

Mfg#
T31-001
T31-002
T31-003
T31-004



Plumbers & Factory Supplies, Inc.

Tools

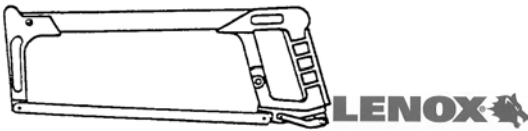

Hack Saw

Mfg#
20918-4012



PVC Plastic Saw

18" blade
12" blade

Mfg#
20980-HSF18
20985-HSF12



Tri-Fold Saw
Wood Saw

Mfg#
20992-3636



Arbor

Mfg#
Specify Size

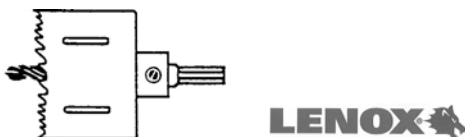

Arbored Hole Saw

Mfg#
Specify Size



Plumbers & Factory Supplies, Inc.

Tools



LENOX 

Close Quarters Saw

Mfg#
20908-908

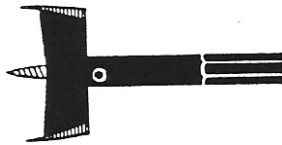

LENOX 

Wood Boring Bits
1" through 4⁵/₈"

Mfg#
Specify Size

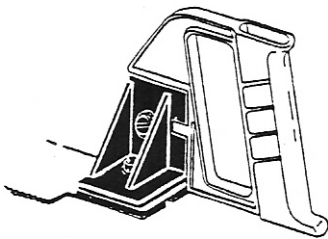

LENOX 

Flush Cut Blade Adaptor

Mfg#
20987-FCBA

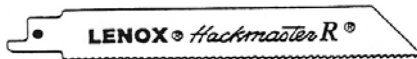

LENOX 





















Blades
Lenox Blades are available in all sizes,
specifications, and in Lenox Gold

Mfg#
Specify Size



Plumbers & Factory Supplies, Inc.

Tools

		Irwin Vise-Grip Quick Adjust Pipe Wrench One handed operation, 40% lighter, smooth release	Mfg# 274001
		Irwin Vise-Grip Locking Pliers Opens to 1 7/8", with wire cutter	Mfg# 05SG
		Irwin Aviation Snips Cutting Capacity 18ga-Cold roll steel and 22ga-stainless steel Requires 25% less force	Mfg# 2073103
		Pro Utility Tool Organizer Enough capacity to carry a broad range of tools and accessories. Tough wear and water resistant plastic base	Mfg# 420-004
		Heavy Duty Pro Bucket Tool Organizer 56 pockets store and organize everything from screws to socket wrenches	Mfg# 420-001
		Pipe Cutters 1/8" x 1 1/8" 1/8" x 1 3/8" 1/8" x 1 3/4" 1/4" x 1 5/8"	Mfg# 21010 21011 21012 21013
		Lenox Gold Retractable Blades Retractable Knife Fixed Blade	Mfg# 20353 20354
		Torpedo Level Lenox Magnetic 9" Torpedo Level. Strong Hold, Easy view, Quick Measure Drainage Slope	Mfg# 21190
		Slip Joint Pliers Sioux Chief Angle Slip Joint Pliers	Mfg# 309-10
		Measuring Tape Empire 25' Power Grip Measuring Tape	Mfg# 7525



Plumbers & Factory Supplies, Inc.

Tools

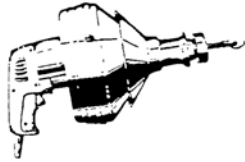

General
PIPE CLEANERS

SuperVee
offers a complete system for cleaning
drain lines through 3" in diameter
1/4" x 25'

Mfg#
SV-F-WC

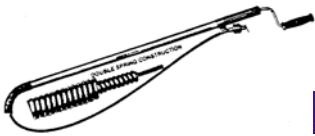

PlumBest
Jones Stephens Corp.

Closet Auger
3ft Auger
6ft Auger

Mfg#
A66-001
A66-005



General
PIPE CLEANERS

Hand Auger
spin through economy drain cleaner
surprising quality in a low-priced tool
25' capacity

Mfg#
R15SM

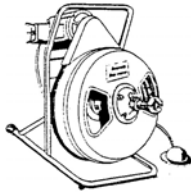

General
PIPE CLEANERS

Mini Rooter
1/3 horsepower motor
3/8" x 75' capacity
inexpensive, lightweight, and time saving

Mfg#
MR-B

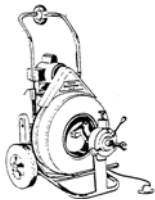

General
PIPE CLEANERS

Speedrooter 91
root cutting power plus the ability to do small drain work
compatible with 3/4", 5/8", and 1/2" cable
uses up to 100' cable

Mfg#
PS91C



General
PIPE CLEANERS

Flood Guards
2" float model
3" float model
4" float model
Stand Pipe Model

Mfg#
2F
3F
4F
S3F



General
PIPE CLEANERS

Auto Cut
Great tool for tight spots where there isn't enough room for
a full size tubing cutter, and ideal for stub out work
1/2" or 3/4" tubing cutters available
1/2" or 3/4" ratchet handles available
replacement cutter wheels available

Mfg#
ATC12
ATC34
RH12
RH34
ATCW



Plumbers & Factory Supplies, Inc.

Tools

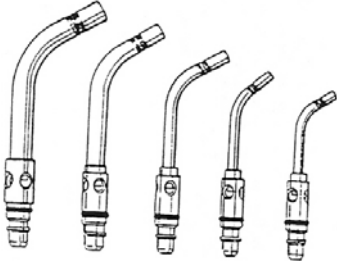

Torch Tips

- $\frac{3}{16}$ " tip
- $\frac{1}{4}$ " tip
- $\frac{5}{16}$ " tip
- $\frac{3}{8}$ " tip
- $\frac{7}{16}$ " tip

- Mfg#
A-2
A-3
A-5
A-8
A-11



Acetylene Torch Kit

- Mfg#
X3B



Torch and Regulator

- Mfg#
STK-9

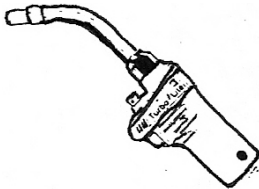

Self-Igniting Hand Torch

- Mfg#
LT90



One piece hand held 2730 degree butane torch

- Mfg#
MT-850

Repair Parts Also Available





Plumbers & Factory Supplies, Inc.

Pipe & Fittings

Pipe

Black (T & C) ½" – 2" Diameter x 21' length

Copper Tube ½" – 2" Diameter x 10' – 20' – 40' – 50' – 60' – 100' length

PVC Schedule 40 1½" - 6" Diameter x 10' - 20' length

ABS Schedule 40 1½" - 6" Diameter x 10' - 20' length

Fittings

Black Malleable

90
45
St 90
St 45
Tee
Couplings
Unions
Reducers
Caps
Plugs

Copper

90
45
St 90
St 45
Tee
Couplings
Unions
Reducers
Caps
Fitting Reducers

PVC/ABS

90
45
60
22½
St 90
St 45
Tee
Wyes
Coupling
Reducers

Many fittings are available that are not listed above. To check on the availability of a fitting not listed, just call us at P & F for a stock check.



Plumbers & Factory Supplies, Inc.

Save Time- Phone Or Fax In Your Order

p. 614-476-2645 f. 614-478-4111

Sold To: _____

Also Accepted



Mfg#	Order Quantity	Description	Catalog Page #



Plumbers & Factory Supplies, Inc.

CREDIT APPLICATION / AGREEMENT

Business Legal Name: _____ Date: _____

Business Address: _____ P.O. Box _____

City, State, Zip: _____

Phone: (____) _____ Fax: (____) _____ Mobile: (____) _____

Gross Sales: \$ _____ For Fiscal Year: _____ Length of Time in Business: _____

Taxpayer I.D. # _____ SSN: _____ Driver's License # _____ State Issued: _____

Form of Ownership: Proprietorship Partnership Corporation LLC

If Corporation or LLC: Statutory Agent: _____

Address: _____

City: _____ State: _____ Zip: _____

Bank Name: _____ Branch: _____

Checking Account # _____ Savings Account # _____ Other Acct: _____

If Proprietorship or Partnership: MasterCard # _____ Expiration Date: _____

Visa # _____ Expiration Date: _____

Amount of Credit Requested: \$ _____ Number of Employees: _____ Taxable or Exempt?

(if exempt, an exemption certificate will be required)

PRINCIPAL INFORMATION (must list all principals with 20% or more ownership. Use extra sheet if necessary)

Name: _____ Title: _____

D.O.B. _____ SSN: _____ Personal Net Worth: _____ Annual Personal Income: _____

Present Address: _____

City, State, Zip: _____ Residence Own? _____ Rent? _____

Name of Spouse (if applicable): _____ D.O.B. _____

Name: _____ Title: _____

D.O.B. _____ SSN: _____ Personal Net Worth: _____ Annual Personal Income: _____

Present Address: _____

City, State, Zip: _____ Residence Own? _____ Rent? _____

Name of Spouse (if applicable): _____ D.O.B. _____



Plumbers & Factory Supplies, Inc.

OTHER INFORMATION :

		Yes	No	If "Yes", please explain
1.	Is the business Involved in any claim or lawsuit?	___	___	_____
2.	Has the business ever filed bankruptcy or had a repossession or judgement taken against it?	___	___	_____
3.	Is the business contemplating filing bankruptcy?	___	___	_____
4.	Are any taxes currently unpaid by the business?	___	___	_____

TRADE REFERENCES:

Company Name	Address	Phone Number	Fax Number	Contact Name

TYPE OF BUSINESS: (so that we may determine your product requirements; please mark appropriate line which most closely describes your operation)

<input type="checkbox"/>	Residential Plumbing, New	<input type="checkbox"/>	Home Builder	<input type="checkbox"/>	Industrial Maintenance
<input type="checkbox"/>	Repair Plumbing	<input type="checkbox"/>	General Contractor	<input type="checkbox"/>	Institutional Maintenance
<input type="checkbox"/>	Remodeling Contractor	<input type="checkbox"/>	Kitchen & Bath Dealer	<input type="checkbox"/>	Resale/Retail to the public
<input type="checkbox"/>	Property Maintenance (apartment)	<input type="checkbox"/>	Non-Residential Plumbing	<input type="checkbox"/>	Pumps/Water conditioning
<input type="checkbox"/>	Heating Contractor	<input type="checkbox"/>	Other (please Specify) _____		

Estimated Annual Plumbing Purchases: _____ Do you expect to utilize our showroom services? ___ Yes ___ No

What type of products do you expect to purchase most frequently?

_____ Water Heaters _____ Pipe & Fittings _____ Faucets _____ Parts _____ HVAC



Plumbers & Factory Supplies, Inc.

(Note: a 2% per/month late charge will apply to accounts which are over 30 days past due)

The undersigned have the power and authority to enter into and perform this Agreement and to consummate the transactions contemplated hereby on behalf of the above stated entity. This application is submitted to obtain credit privileges on behalf of the entity and I/We (hereinafter "I" or "my") certify that all information herein is true and complete. The number shown on this form is the correct taxpayer identification number for the entity (or it is waiting for a number to be issued). I authorize Plumbers and Factory Supplies, Inc. to retain property of this application, to rely on the foregoing to check and verify the credit history, to secure follow-up credit reports and to exchange information about this account with the proper persons, creditors and credit bureaus. I authorize our bank and other references listed to release and/or verify information to Plumbers and Factory Supplies, Inc. at any time. I acknowledge that this application is subject to approval of credit acceptance by Plumbers and Factory Supplies, Inc. If this application is approved, this entity agrees to abide by the credit terms referenced herein and which shall be issued by Plumbers & Factory Supplies, Inc. from time to time. I/We authorize Plumbers & Factory Supplies, Inc. to check my/our personal credit and employment history to secure follow-up credit reports and answer questions about my/our credit history in connection with my/our company's application for credit.

Company's complete legal name:

SIGNATURE OF APPLICANT(S)

The undersigned hereby certifies that he/she is authorized by the above stated entity to sign the application and to bind the above entity to all the terms and conditions as set forth above.

By: X _____ Title: _____

Print Name: _____ Date Signed: _____

Signature of Principal

Signature of Principal

 Print Name Date
 X _____
 Signature Date

 Print Name Date
 X _____
 Signature Date

GUARANTY

In consideration of Plumbers & Factory Supplies, Inc. extending credit per this application, I hereby absolutely and unconditionally personally guarantee the full and punctual payment of my obligation of the company and I hereby bind myself to pay on demand any sum, including all costs of collection and reasonable attorney's fees which may become due to Plumbers & Factory Supplies, Inc. by the company whenever the company shall fail to pay same. It is understood that this guaranty shall be continuing and irrevocable guaranty and indemnify for such indebtedness of the company and shall remain so until otherwise agreed to in writing by Plumbers & Factory Supplies, Inc. I do hereby waive notice of demand, protest or default and consent to any modification or renewal of the credit agreement hereby guaranteed.

Signature of Individual Guarantor(s) of company

 Print Name Date
 X _____
 Individual Signature Date

 Print Name Date
 X _____
 Individual Signature Date